

FEATURES

- Identification of large signal model in real time
- Electrical and mechanical state variables (displacement, temperature, ...)
- For woofers in free air, sealed and vented enclosures
- For micro-speakers, headphones, mini-loudspeakers, tweeters, shakers
- Measures signal distortion on-line
- Full thermal and mechanical driver protection
- Finds dominant sources of distortion
- Locates weak points in design and assembly

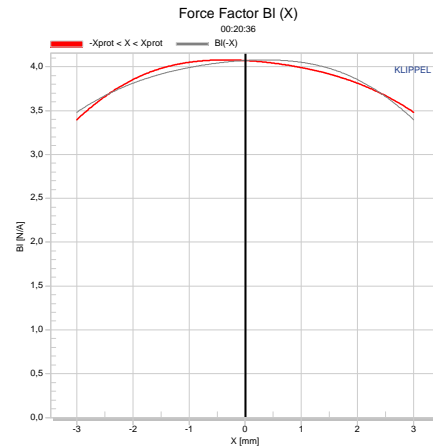

DESCRIPTION

The module LSI3 identifies the elements of the lumped parameter model of woofers, micro-speakers, headphones, tweeters, shakers, mini-loudspeakers and other electro-dynamical transducers. It allows to measure transducers mounted in an enclosure or in free air. The transducer is operated under normal working conditions and excited with a broadband noise signal. Starting in the small-signal domain the amplitude is gradually increased up to limits admissible for the particular transducer. The maximal amplitude is determined automatically using the identified transducer parameters and general protection parameters describing the thermal and mechanical load.

The identification of the model parameters is performed in real time using an adaptive system. It is based on the estimation of the back EMF from the voltage $U(t)$ and current signal $I(t)$ measured at the electrical terminals. The identified model allows locating the sources of the nonlinear distortion and their contribution to the radiated sound. The dynamic generation of a DC-part in the displacement, amplitude compression and other nonlinear effects can be investigated in detail.

LSI3 Module	Article number
LSI3 Woofer - Large Signal Identification Woofer	2000-250
LSI3 Micro-speaker - Large Signal Identification Micro-speaker	2000-260

CONTENT

- 1 Overview 3
- 2 Requirements 8
- 3 Limitations 8
- 4 Output 9
- 5 References 10
- 6 Patents 10

1 Overview

1.1 Principle

The transducers considered here have a moving-coil assembly performing an electro-dynamical conversion of the electrical quantities (current and voltage) into mechanical quantities (velocity and force) and vice versa.

Equivalent Circuit

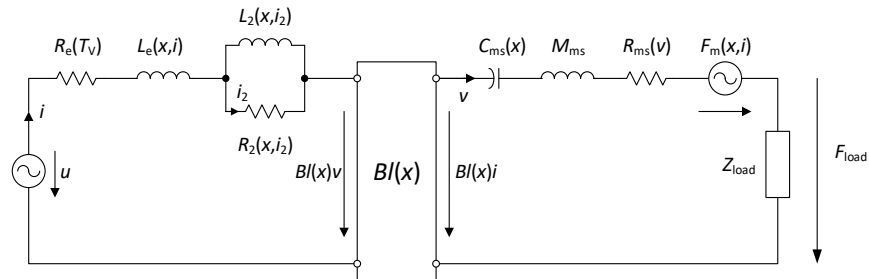

The lumped-parameter model shown above is used to describe the large signal behavior of electro-dynamical drivers at high amplitudes. In contrast to the well-known linear model the elements

- electro-dynamical force factor $BL(x)$,
- compliance of mechanical suspension $C_{ms}(x)$,
- voice coil inductance represented by $L_e(x,i)$, $L_2(x,i_2)$ and $R_2(x,i_2)$,
- mechanical losses $R_{ms}(v)$
- resistance of the voice coil at DC represented by $R_e(T_v)$

are not constant parameters but depend on one or more speaker states (displacement x , input current i , voice coil temperature T_v).

The additional impedance Z_{load} represents any additional mechanical or acoustical resonance caused by vented enclosure, panel, and horn. For a driver operated in free air the lumped parameter model assumes the impedance Z_{load} to be 0.

For the vented box system the mechanical load Z_{load} can be represented by the following equivalent circuit.

For the sealed-box system the mechanical load Z_{load} can be represented by the following equivalent circuit.

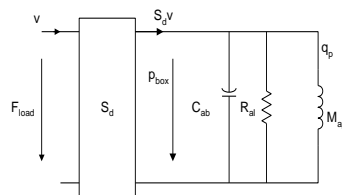

using acoustical compliance C_{ab}

$$C_{ab} = \frac{V_0}{\rho_0 c_0^2}$$

representing the compression of the air volume V_0 with air density ρ_0 and speed of sound c_0 . The Helmholtz resonance and Q factor are defined by

$$f_b = \frac{1}{2\pi} \frac{1}{\sqrt{M_{ap} C_{ab}}} \quad Q_b = \frac{1}{2\pi f_b C_{ab} R_{al}}$$

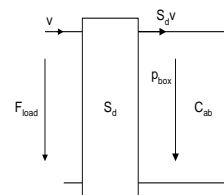

using mechanical compliance C_{mb}

$$\frac{x}{F_{load}} = C_{mb} = \frac{1}{K_{mb}} = \frac{C_{ab}}{S_d^2} = \frac{V_0}{\rho_0 c_0^2 S_d^2}$$

which can be expressed by air volume V_0 , air density ρ_0 and speed of sound c_0 .

A total stiffness $K_{mt}(x) = K_{ms}(x) + K_{mb}$ can be calculated.

Operation Condition

During the Large Signal Identification the transducer has to be operated in free air, in a sealed or in a vented enclosure. It is not recommended to attach an additional mass to the moving assembly because this mass might fall off at higher displacements.

1.2 Identification Technique

Principle

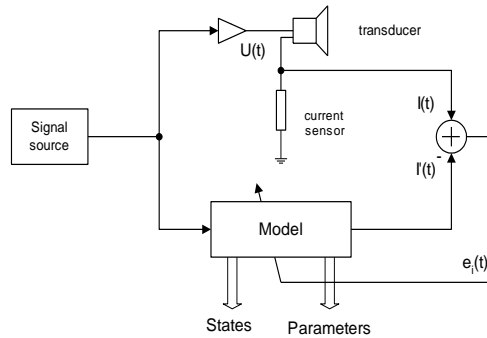

The transducer model is implemented as an adaptive system in a digital signal processor (DSP). The transducer is persistently excited by a broadband noise or multi-tone signal generated by a signal source via a power amplifier. The model which is excited with the voltage $U(t)$ estimates the voice coil current $I'(t)$ which is then compared with the measured current $I(t)$. The amplitude of the difference signal (error) is minimized by adjusting the model parameters adaptively.

The output parameters are the optimal parameter estimates, the instantaneous state variables (displacement) and statistical values (RMS or peak value, crest factor) which may be investigated. There are two different LSI modules:

- LSI3 Woofer
- LSI3 Micro-speaker

which are defined below.

LSI3 Woofer

The LSI3 Woofer allows to measure woofers and other electro-dynamical transducers operated in free-air or coupled with an additional mechanical or acoustical resonator (vented enclosure, horn, panel) giving a total mechanical-acoustical system of 2nd or 4th-order.

There are three working modes:

- Free air:
Dedicated for woofers operated in free air. It assumes that the impedance $Z_{load}=0$.
- Sealed enclosure:
The stiffness $K_{ms}(x)$ of the mechanical suspension is calculated from the total stiffness $K_{mt}(x)$. $K_{mt}(x)$ is the sum of the mechanical stiffness $K_{ms}(x)$ and the equivalent stiffness K_{mb} of the enclosed air in the enclosure which is calculated by using the air volume V_b and radiation area S_d of the cone provided by the user.
- Vented enclosure:
For a vented enclosure the mechanical stiffness $K_{ms}(x)$ of the driver can be separated by considering the imported air volume V_b and radiation area S_d . The port resonance frequency f_b and Q_b factor is determined. This mode may be also used for measuring drive units coupled to an unknown additional resonator (e.g. first break-up mode on a panel) which is assumed to be linear.

LSI3 Micro-speaker

This module is dedicated for micro-speakers, tweeters, and horn compression drivers and which may be modeled by a 2nd-order mechanical system with a resonance frequency between 100 Hz and 1.5 kHz.

Import Parameter

The minimal setup measures the electrical impedance at the transducer terminals and identifies the electrical system in absolute quantities whereas the mechanical system is identified in relative quantities only. Importing one mechanical parameter (moving mass M_{ms} or $B/(x=0)$ at the rest position) allows to calibrate all state variables (e.g. the displacement in mm) and all of the mechanical parameters (e.g. compliance in mm/N).

<p>Laser</p>		<p>A laser sensor based on triangulation principle (see <i>A2 Laser Displacement Sensor</i>) can be used for measuring the voice coil displacement during the test. This information is used to calibrate the mechanical parameters in absolute terms.</p>
<p>Adaption</p>	<p>The estimation of the linear and nonlinear parameters consists of a series of steps processed sequentially:</p> <ul style="list-style-type: none"> • Amplifier check (cables, gain control, limiting) • Measurement of resistance R_e at DC • Identification of the linear lumped parameters valid in the small signal domain • Identification of the admissible amplitude and the nonlinear parameters describing the transducer over its whole working range 	
<p>Acoustical Environment</p>	<p>The influence of the room acoustics on the driver parameters may be neglected having a normal room size (volume > 30 m³) and keeping a distance of about 1 m to the walls.</p>	

1.3 Results

TRANSDUCER NONLINEARITIES

<p>Force Factor (BI-product)</p>		<p>The force factor $BI(x)$ describes the integral of the induction B versus wire length l depending on the instantaneous coil position x in the gap. The $BI(x)$ curve comprises a symmetrical and an asymmetrical component and decreases at high displacements. The asymmetry may be caused by the field geometry or by an offset of the coil. Variation of $BI(x)$ versus x affects the parametric excitation of the driver (varying driving force) and the electrical damping at the resonance (loss factor Q_{es} is not constant).</p>
<p>Stiffness of Mechanical Suspension</p>		<p>The stiffness $K_{ms}(x)$ which is the inverse of the compliance $C_{ms}(x)$ describes the ratio of the instantaneous force and displacement at the working point x. A steep increase of the stiffness indicates the limit of the moving capability of the mechanical suspension. A variation of $K_{ms}(x)$ corresponds with an instantaneous variation of the resonance frequency $f_s(x)$ and the mechanical loss factor $Q_{ms}(x)$ versus displacement.</p>

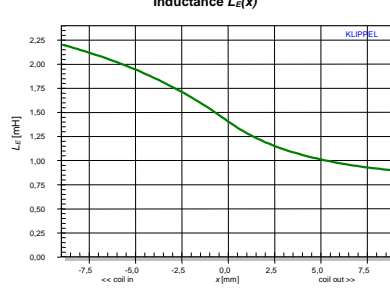
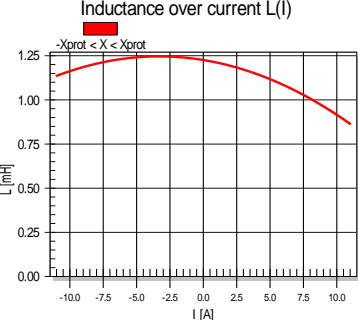
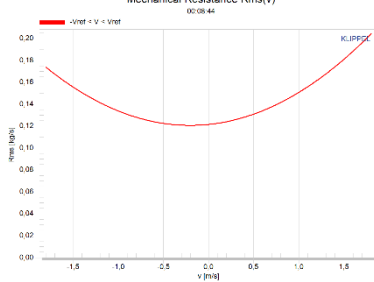
<p>Voice Coil Inductance versus displacement¹</p>		<p>The parameters representing the voice coil inductance $L_e(x)$, $L_2(x)$ and $R_2(x)$ are assumed to have the same nonlinear characteristic. Transducers not comprising components for reducing the inductance such as shorting rings or a pole cap have an asymmetrical shape. In this case the inductance increases when the voice coil is moved towards the back plate. Variation of the inductance parameters will affect the electrical impedance and produces a reluctance force on the mechanical side which may be interpreted as an additional electromagnetic driving mechanism.</p>
<p>Voice Coil Inductance versus current¹</p>		<p>The nonlinear $B(H)$ characteristic of the iron causes a variation of the inductance $L(i)$ versus voice coil current i. This nonlinearity is also called flux modulation or better permeability modulation. A symmetric characteristic shows a saturation of the iron at high positive and negative current. The curve becomes asymmetric for a high DC flux generated by the magnet. The parameter $L(i)$ causes harmonic distortion at higher frequencies which can easily be detected in the input current.</p>
<p>Mechanical Resistance versus velocity²</p>		<p>The dependency of the mechanical resistance R_{ms} on voice coil velocity v is a dominant nonlinearity in micro-speakers and other transducers which have a relatively high resonance frequency f_s, a relatively small force factor Bl and a total quality factor Q_{ts} dominated by the mechanical losses. The $R_{ms}(v)$ nonlinearity causes a significant increase of the mechanical damping at resonance frequency, causing a nonlinear amplitude compression of the fundamental and generating significant harmonic and intermodulation distortion. There are strong indications that the nonlinear variation of $R_{ms}(v)$ nonlinearity is not caused by the mechanical vibration of the diaphragm or other mechanical elements because this nonlinearity vanishes when the transducer is operated in vacuum.</p>
<p>TEMPORAL VARIATIONS OF STATES AND PARAMETERS</p>		
<p>Permanent Monitoring</p>	<p>During the identification process all of the parameter estimates and important characteristics of the state variables (peak and RMS values) are sampled periodically (about 2 –10 s) and recorded by the Klippel Analyzer. The complete recorded history can be analyzed to investigate temporal variations of the parameters due to thermal, reversible and irreversible processes.</p>	
<p>Temperature, Power</p>	<p>The voice coil temperature, the real input power P_{real} and the power P_{Re} dissipated on resistance R_e is permanently measured and recorded. This information is helpful to protect the driver against overload but is also used to identify the thermal parameters.</p>	

¹ LSI3 Woofer only

² LSI3 Microspeaker only

	<p style="text-align: center;">Electrical Power and Temperature 00:20:36</p>
<p>Stiffness of Mechanical Suspension</p>	<p>The properties of the mechanical suspension vary with time due to reversible and non-reversible processes (creep, ageing).</p> <p style="text-align: center;">fs(t), Kms(t), Rms(t) 00:20:36</p>
<p>Distortion Analysis</p>	<div style="display: flex; justify-content: space-between;"> <div style="width: 45%;"> </div> <div style="width: 50%;"> <p>The transducer may be modeled as a superposition of a linear system excited by the input signal and the outputs of nonlinear subsystems corresponding to the driver nonlinearities $B(x)$, $C_{ms}(s)$, $L_e(x)$ and $L_e(i)$.</p> <p>The implemented digital model makes it possible to measure the peak values of the outputs $p_{C(x)}(t)$, $p_{B(x)}(t)$, $p_{L(i)}(t)$ and $p_{L(x)}(t)$ of the nonlinear subsystems separately and to refer this to the peak value of the total output p_{total}. This ratios are called instantaneous distortions d_c, d_{Bl}, d_L and $d_{L(i)}$ show the contribution from each nonlinearity versus measurement time.</p> <p>This kind of Distortion Analysis shows the dominant source of distortion.</p> </div> </div> <p style="text-align: center;">Distortion 00:20:36</p>

2 Requirements

2.1 Hardware

Product	Article	Spec
Klippel Analyzer 3	2000-300	H3
High Current Bypass Box (optional)		
Laser (optional)		A2

2.2 Software

Product	Article	Spec
dB-Lab (version 210.xx or higher)		F1
LSI3 Woofer (version 1.0 or higher)	2000-250	S52
LSI3 Micro-speaker (version 1.0 or higher)	2000-260	

3 Limitations

3.1 Device Under Test

Parameter	Symbol	Min	Typical	Max	Unit
Voice coil resistance					
LSI3 Woofer	R_e	0.5	2-8	25	Ω
LSI3 Micro-speaker	R_e	1	4-30	100	Ω
Resonance frequency for					
LSI3 Woofer	f_s	15		400	Hz
LSI3 Micro-speaker	f_s	100		1500	Hz
Total loss factor	Q_t	0.3		6	
Voice-coil inductance	L_e	0.01		5	mH

3.2 Power Amplifier

Parameter	Symbol	Min	Typical	Max	Unit
Maximum input level				15	dBu
Frequency response				1	dB
Ref. 1kHz @ 5 Hz ... 20 kHz					
Input sensitivity at rated output power			0 (775)		dBu (mV)
Signal processing latency @ Woofer				9.5	ms
Signal processing latency @ Tweeter / Micro-speaker				3.5	ms

3.3 Input Parameters

Parameter	Symbol	Min	Typical	Max	Unit
PROTECTION LIMITS					
Small signal voltage	u_{small}	0.125	0.5	5	V
Small signal gain	G_{small}	-20		0	dB
Allowed increase of voice coil temperature ΔT_v ,	ΔT_{lim}	0	60	300	K

Allowed minimal value of the force factor ratio Bl_{\min}	Bl_{\lim}	25	50	100	%
Allowed minimal value of the mechanical compliance ratio C_{\min}	C_{\lim}	20	50	100	%
Allowed maximal value of electric input power P.	P_{\lim}	0.01		999	W
STIMULUS					
SIGNAL CHARACTERISTICS CAN BE ADJUSTED AUTOMATICALLY FOR THE DUT CONNECTED.					
Spectral Noise characteristic	pink or white noise (multi-tone for Micro-speaker)				
Cut-off frequency of high pass for Woofer (for Tweeter / Micro-speaker)	f_{hp}	10 (40)		150 (1200)	Hz
Cut-off frequency of low pass for Woofer (for Tweeter / Micro-speaker)	f_{lp}	200 (400)		1500 (4000)	Hz
MATERIAL, IMPORTED PARAMETERS					
Effective area of the driver diaphragm	S_d	0<		10000	cm ²
Material of voice coil	Copper, aluminum or custom temperature coefficient				
Temperature coefficient of voice coil material	alpha	0.001	0.0038	0.01	K ⁻¹
Force factor at rest position ³	$Bl(x=0)$	0<		100	N/A
Moving mass ³	M_{ms}	0.001		10	kg
Box volume	V_b	0<		1000	liter

4 Output

PARAMETERS AT THE REST POSITION (X=0)	
Electrical parameters $x \ll X_{max}$	$R_e, L_e, L_2, R_2, C_{ms}, L_{ces}, R_{es}$
Mechanical parameters $x \ll X_{max}$	$M_{ms}, R_{ms}, C_{ms}, Bl$
Derived parameters $x \ll X_{max}$	$Q_{ts}, Q_{ms}, Q_{es}, f_s$ V_{as}, η_0, L_m
Vented box parameters	Q_b, f_b
Temperature, power compression	$\Delta T_v, PC$
Predicted Impedance Magnitude	$Z(f)$
STATES	
Modeling and Measurement Errors	E_i, E_x, E_u
Nonlinear Parameter Variation	$Bl_{\min}, C_{\min}, L_{\min}$
Displacement	$X_{peak}, X_{bottom}, X_{dc}, X_{prot}$
Electrical signals	$u_{peak}, i_{peak}, u_{rms}, i_{rms}, P_{real}, P_{Re}$
Analyzed distortion components	d_b, d_c, d_i, d_r
NONLINEAR PARAMETERS	
Force factor (Bl -product)	$Bl(x), Bl(x_{rel}) / Bl(0)$
Suspension characteristic	$K_{ms}(x), C_{ms}(x), C_{ms}(x_{rel})/C_{ms}(0)$
Displacement varying Inductance	$L_e(x), L_e(x_{rel})$
Current varying Inductance ("flux modulation")	$L_e(i)$
Mechanical losses	$R_{ms}(v)$
Coefficients of power series for $Bl(x), C_{ms}(x), L(x)$	up to 8 th order
Derived parameters	$Q_{ts}(x, T_v), f_s(x)$
Displacement Limits	$x_{Bl}(Bl_{\min}), x_c(C_{\min}), x_L(Z_{max}), x_d(d_2)$

³ absolute identification of the mechanical parameters without laser sensor requires import of $Bl(x=0)$ or M_{ms}

Asymmetry	x_{sym}, a_{bl}, a_{kms}
Total Stiffness (suspension + air) in sealed enclosure	$K_{mt}(x)$
THERMAL PARAMETERS	
Thermal resistance	R_{th}
HISTORY	
Parameter and state variation versus measurement time t	
Background monitoring at high sample rate (Death Report)	
EXPORT	
Result windows to report generator	
Graphics to Clipboard, File (various formats)	
Parameters for Simulation	

5 References

5.1 Related Modules	LSI for Klippel Distortion Analyzer (DA)
5.2 Manuals	Large Signal Identification for KA3

6 Patents

Germany	102007005070 1020120202717 19714199 43340407 P4332804.0
USA	8,078,433 14/436,222 6,058,195 5815585
China	8,078,433 14/436,222 6,058,195 5815585
Japan	5364271 2972708
Europe	13786635.6
Taiwan	102137485
India	844/MUMNP/2015
Great Britain	2324888
Hong Kong	1020403

Find explanations for symbols at:

<http://www.klippel.de/know-how/literature.html>

Last updated: December 07, 2018

